

*Generate the Next Inspirations*

**PRODUCT CATALOGUE**





# GNI ORTHO's Mission

GNI ORTHO provides state-of-the-art orthodontic products that are developed in Korea and marketed worldwide.

GNI ORTHO is recognized as the premier orthodontic products provider to dentists across Asia, the Middle East, and Europe with nine regional offices in mainland China and distribution partners in more than 20 countries throughout Asia.

Since 2006, GNI ORTHO has been providing professional quality orthodontic products at the best value in the industry. It has since then grown consistently in sales and outreach every year.

Its dedication to providing the highest level of product quality, reliable delivery, and personalized service represents GNI ORTHO's firm commitment to gaining and upholding clients' trust and to bringing forth more excellence in the future.





# ORTHODONTIC CONTENTS



**BRACKETS** ● ————— PAGE 7

**ARCH WIRES** ● ————— PAGE 19

**TUBES** ● ————— PAGE 22

**ELASTIC RINGS** ● ————— PAGE 24

**ORAL CAVITY** ● ————— PAGE 27

— Inside oral cavity

— Outside oral cavity

**MINI SCREWS** ● ————— PAGE 29

# ORTHODONTIC BRACKET

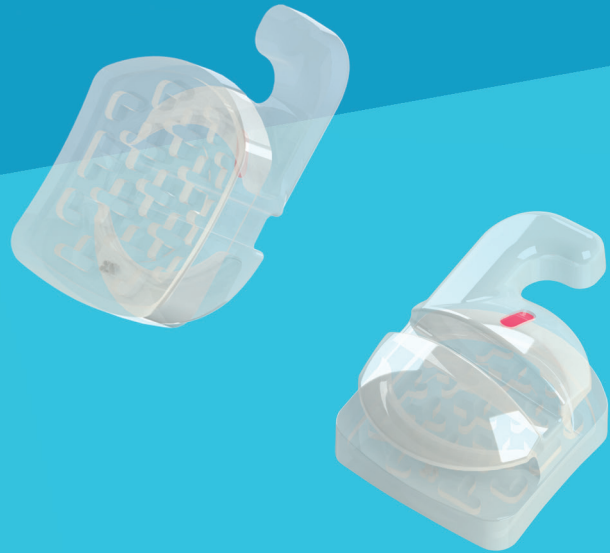

## AESTHETIC SERIES

Sapphire Bracket \_ 7

Ceramic Bracket \_ 10

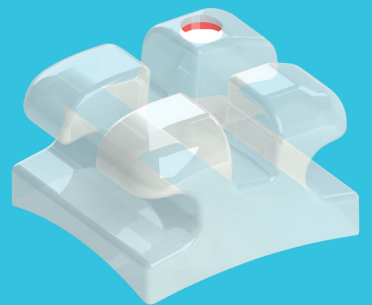

## METAL SERIES

Metal Mini Bracket \_ 13

Metal CNC Process Bracket \_ 16

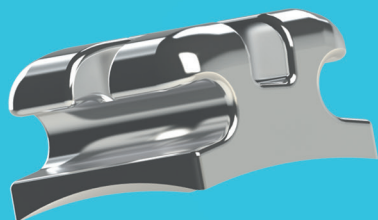
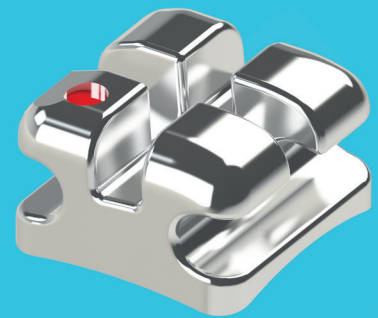



# ROSA

# SAPPHIRE

## BRACKET

AESTHETIC SERIES

### Translucent body

Provides aesthetically pleasant smile

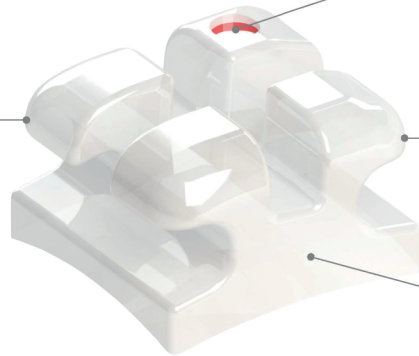

### Removable color-coded I.D. mark

For simple and accurate bracket selection

### Smooth tie-wings

Engineered to provide superior patient comfort

### High quality material

Made from monocrystalline sapphire



### Bonding base

Alumina powder coating base maximized bonding retention



### Ample tie wings area

For easy chain and tie ligation

- Pure Monocrystalline sapphire bracket features perfect transparency.
- Optimized body strength, including tie wings by a special heating system.
- Rounded edge, low profile design reduces the patient's discomfort.
- Unique base coating mechanics increase bonding durability and provide comfortable debonding.
- Exceptionally affordable.
- Convenient to attach by holding the indicator using bracket tweezers.

### ROSA Patient Kits

Description	EDGEWISE		ROTH		MBT	
	018	022	018	022	018	022
Upper/Lower 3-3 HK3	RSE-18-331	RSE-22-331	RSR-18-331	RSR-22-331	RSM-18-331	RSM-22-331
Upper 3-3 HK3	RSE-18-301	RSE-22-301	RSR-18-301	RSR-22-301	RSM-18-301	RSM-22-301
Lower 3-3 HK3	RSE-18-031	RSE-22-031	RSR-18-031	RSR-22-031	RSM-18-031	RSM-22-031
Upper/Lower 5-5 HK3	RSE-18-551	RSE-22-551	RSR-18-551	RSR-22-551	RSM-18-551	RSM-22-551
Upper 5-5 HK3	RSE-18-501	RSE-22-501	RSR-18-501	RSR-22-501	RSM-18-501	RSM-22-501
Lower 5-5 HK3	RSE-18-051	RSE-22-051	RSR-18-051	RSR-22-051	RSM-18-051	RSM-22-051
Upper/Lower 5-5 HK345	RSE-18-553	RSE-22-553	RSR-18-553	RSR-22-553	RSM-18-553	RSM-22-553
Upper 5-5 HK345	RSE-18-503	RSE-22-503	RSR-18-503	RSR-22-503	RSM-18-503	RSM-22-503
Lower 5-5 HK345	RSE-18-053	RSE-22-053	RSR-18-053	RSR-22-053	RSM-18-053	RSM-22-053





## AESTHETIC SERIES

## ROSA Sapphire ROTH Bracket

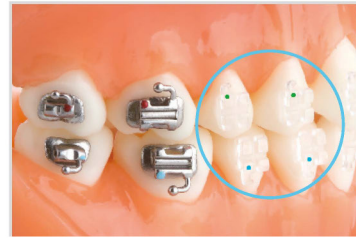

## Maxillary

torque		-7°	-7°	-2°	8°	11°	11°	8°	-2°	-7°	-7°	
ang.		0°	0°	8°	9°	5°	5°	9°	8°	0°	0°	
width		3.05	3.05	3.4	2.9	3.05	3.05	2.9	3.4	3.05	3.05	
Item no.	18	w/hook	RSR-18-14H	RSR-18-14H	RSR-18-13H	RSR-18-12	RSR-18-11	RSR-18-21	RSR-18-22	RSR-18-23H	RSR-18-24H	RSR-18-24H
		w/o hook	RSR-18-14	RSR-18-14							RSR-18-24	RSR-18-24
	22	w/hook	RSR-22-14H	RSR-22-14H	RSR-22-13H	RSR-22-12	RSR-22-11	RSR-22-21	RSR-22-22	RSR-22-23H	RSR-22-24H	RSR-22-24H
		w/o hook	RSR-22-14	RSR-22-14							RSR-22-24	RSR-22-24

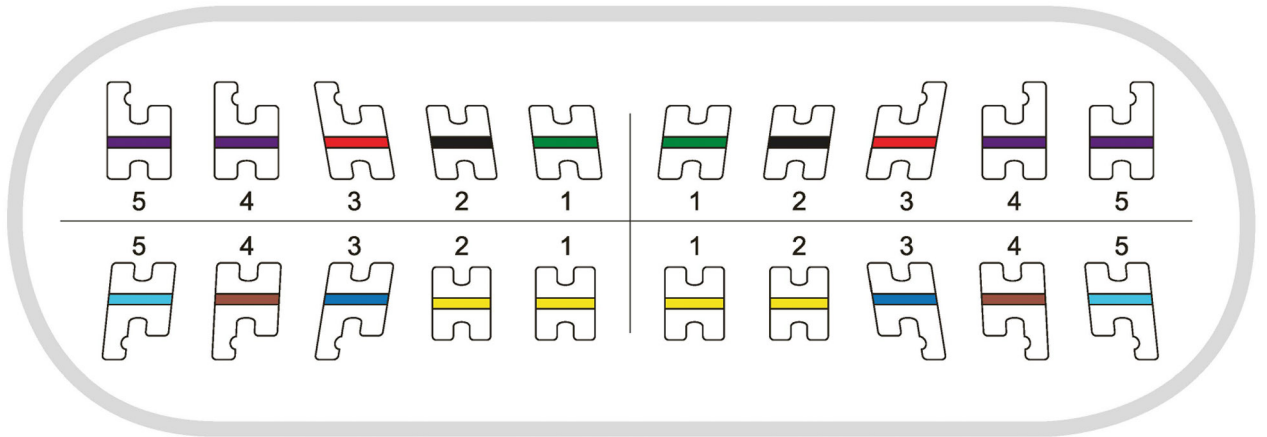

## Mandibular

torque		-21°	-17°	-11°	0°	0°	0°	0°	-11°	-17°	-21°	
ang.		6°	3°	7°	0°	0°	0°	0°	7°	3°	6°	
width		3.15	3.15	3.4	2.85	2.85	2.85	2.85	3.4	3.15	3.15	
Item no.	18	w/hook	RSR-18-45H	RSR-18-44H	RSR-18-43H	RSR-18-41	RSR-18-41	RSR-18-31	RSR-18-31	RSR-18-33H	RSR-18-34H	RSR-18-35H
		w/o hook	RSR-18-45	RSR-18-44							RSR-18-34	RSR-18-35
	22	w/hook	RSR-22-45H	RSR-22-44H	RSR-22-43H	RSR-22-41	RSR-22-41	RSR-22-31	RSR-22-31	RSR-22-33H	RSR-22-34H	RSR-22-35H
		w/o hook	RSR-22-45	RSR-22-44							RSR-22-34	RSR-22-35



AESTHETIC SERIES

ROSA Sapphire MBT Bracket



Maxillary

torque		-7°	-7°	0°	10°	17°	17°	10°	0°	-7°	-7°	
ang.		0°	0°	8°	8°	4°	4°	8°	8°	0°	0°	
width		3.05	3.05	3.4	2.9	3.05	3.05	2.9	3.4	3.05	3.05	
Item no.	18	w/hook	RSM-18-14H	RSM-18-14H	RSM-18-13H	RSM-18-12	RSM-18-11	RSM-18-21	RSM-18-22	RSM-18-23H	RSM-18-24H	RSM-18-24H
		w/o hook	RSM-18-14	RSM-18-14							RSM-18-24	RSM-18-24
	22	w/hook	RSM-22-14H	RSM-22-14H	RSM-22-13H	RSM-22-12	RSM-22-11	RSM-22-21	RSM-22-22	RSM-22-23H	RSM-22-24H	RSM-22-24H
		w/o hook	RSM-22-14	RSM-22-14							RSM-22-24	RSM-22-24

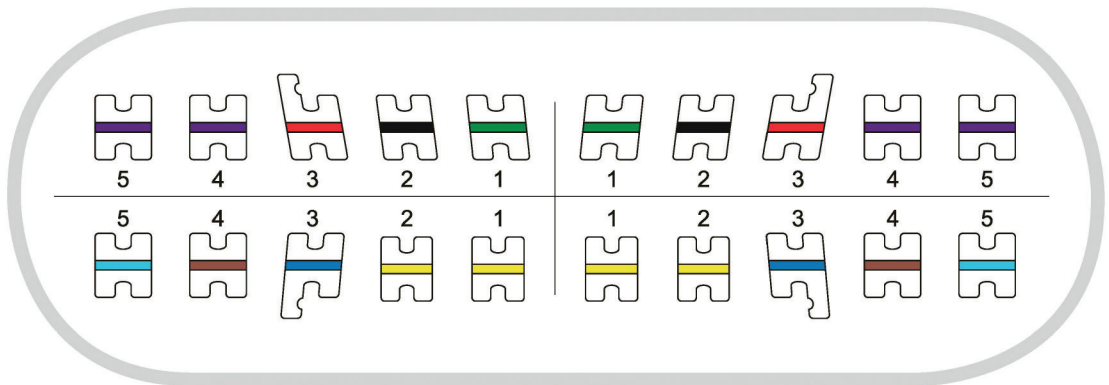

Mandibular

torque		-17°	-12°	0°	-6°	-6°	-6°	-6°	0°	-12°	-17°	
ang.		0°	0°	3°	0°	0°	0°	0°	3°	0°	0°	
width		3.15	3.15	3.4	2.85	2.85	2.85	2.85	3.4	3.05	3.15	
Item no.	18	w/hook	RSM-18-45H	RSM-18-44H	RSM-18-43H	RSM-18-41	RSM-18-41	RSM-18-31	RSM-18-31	RSM-18-33H	RSM-18-34H	RSM-18-35H
		w/o hook	RSM-18-45	RSM-18-44							RSM-18-34	RSM-18-35
	22	w/hook	RSM-22-45H	RSM-22-44H	RSM-22-43H	RSM-22-41	RSM-22-41	RSM-22-31	RSM-22-31	RSM-22-33H	RSM-22-34H	RSM-22-35H
		w/o hook	RSM-22-45	RSM-22-44							RSM-22-34	RSM-22-35





**Bonding base**  
PATENTED double-layered cross-etched base maximized bonding retention



**Ample tie wings area**  
For easy chain and tie ligation

- The new Rose is a 100% translucent ceramic bracket presenting an exceptional aesthetic choice. Smaller body, stronger resistance, smoother edges, and rounded tie-wings provides excellent intraoral comfort for your patients. No more intraoral complaints.
- A patented double-layered cross-etched base is designed to strengthen the bonding retention. Easy and clean debonding with the beveled base edges giving no-stress experience.

## ROSE Patient Kits

Description	EDGEWISE		ROTH		MBT	
	018	022	018	022	018	022
Upper/Lower 3-3 HK3	RCE-18-331	RCE-22-331	RCR-18-331	RCR-22-331	RCM-18-331	RCM-22-331
Upper 3-3 HK3	RCE-18-301	RCE-22-301	RCR-18-301	RCR-22-301	RCM-18-301	RCM-22-301
Lower 3-3 HK3	RCE-18-031	RCE-22-031	RCR-18-031	RCR-22-031	RCM-18-031	RCM-22-031
Upper/Lower 5-5 HK3	RCE-18-551	RCE-22-551	RCR-18-551	RCR-22-551	RCM-18-551	RCM-22-551
Upper 5-5 HK3	RCE-18-501	RCE-22-501	RCR-18-501	RCR-22-501	RCM-18-501	RCM-22-501
Lower 5-5 HK3	RCE-18-051	RCE-22-051	RCR-18-051	RCR-22-051	RCM-18-051	RCM-22-051
Upper/Lower 5-5 HK345	RCE-18-553	RCE-22-553	RCR-18-553	RCR-22-553	RCM-18-553	RCM-22-553
Upper 5-5 HK345	RCE-18-503	RCE-22-503	RCR-18-503	RCR-22-503	RCM-18-503	RCM-22-503
Lower 5-5 HK345	RCE-18-053	RCE-22-053	RCR-18-053	RCR-22-053	RCM-18-053	RCM-22-053





## AESTHETIC SERIES

## ROSE Ceramic ROTH Bracket



## Maxillary

torque		-7°	-7°	-2°	8°	11°	11°	8°	-2°	-7°	-7°	
ang.		0°	0°	8°	9°	5°	5°	9°	8°	0°	0°	
width		3.2	3.2	3.35	2.8	3.05	3.05	2.8	3.35	3.2	3.2	
Item no.	18	w/hook	RCR-18-14H	RCR-18-14H	RCR-18-13H	RCR-18-12	RCR-18-11	RCR-18-21	RCR-18-22	RCR-18-23H	RCR-18-24H	RCR-18-24H
	w/o hook	RCR-18-14	RCR-18-14	RCR-18-13H	RCR-18-12	RCR-18-11	RCR-18-21	RCR-18-22	RCR-18-23H	RCR-18-24	RCR-18-24	RCR-18-24
Item no.	22	w/hook	RCR-22-14H	RCR-22-14H	RCR-22-13H	RCR-22-12	RCR-22-11	RCR-22-21	RCR-22-22	RCR-22-23H	RCR-22-24H	RCR-22-24H
	w/o hook	RCR-22-14	RCR-22-14	RCR-22-13H	RCR-22-12	RCR-22-11	RCR-22-21	RCR-22-22	RCR-22-23H	RCR-22-24	RCR-22-24	RCR-22-24

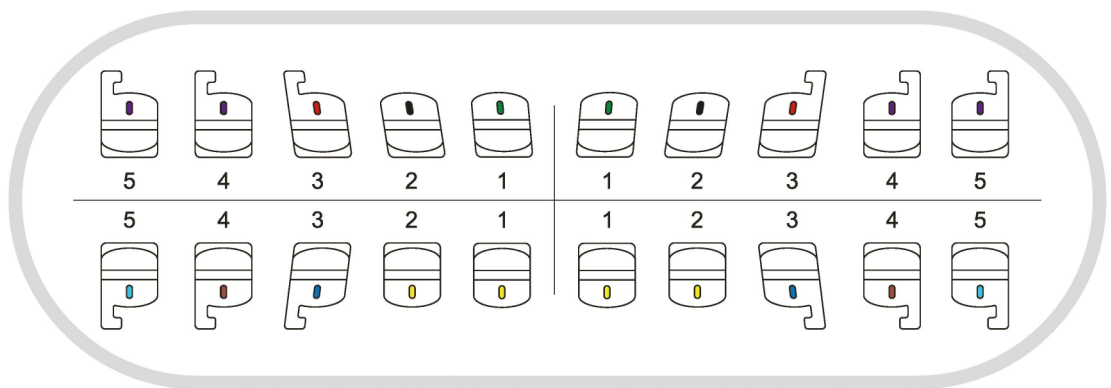

## Mandibular

torque		-22°	-17°	-11°	0°	0°	0°	0°	-11°	-17°	-22°	
ang.		0°	0°	7°	0°	0°	0°	0°	7°	0°	0°	
width		3.25	3.25	3.4	2.75	2.75	2.75	2.75	3.4	3.25	3.25	
Item no.	18	w/hook	RCR-18-45H	RCR-18-44H	RCR-18-43H	RCR-18-41	RCR-18-41	RCR-18-31	RCR-18-31	RCR-18-33H	RCR-18-34H	RCR-18-35H
	w/o hook	RCR-18-45	RCR-18-44	RCR-18-43H	RCR-18-41	RCR-18-41	RCR-18-31	RCR-18-31	RCR-18-33H	RCR-18-34	RCR-18-35	RCR-18-35
Item no.	22	w/hook	RCR-22-45H	RCR-22-44H	RCR-22-43H	RCR-22-41	RCR-22-41	RCR-22-31	RCR-22-31	RCR-22-33H	RCR-22-34H	RCR-22-35H
	w/o hook	RCR-22-45	RCR-22-44	RCR-22-43H	RCR-22-41	RCR-22-41	RCR-22-31	RCR-22-31	RCR-22-33H	RCR-22-34	RCR-22-35	RCR-22-35





## AESTHETIC SERIES

# ROSE Ceramic MBT Bracket



### Maxillary

torque		-7°	-7°	0°	10°	17°	17°	10°	0°	-7°	-7°	
ang.		0°	0°	8°	8°	4°	4°	8°	8°	0°	0°	
width		3.2	3.2	3.35	2.8	3.05	3.05	2.8	3.35	3.2	3.2	
Item no.	18	w/hook	RCM-18-14H	RCM-18-14H	RCM-18-13H	RCM-18-12	RCM-18-11	RCM-18-21	RCM-18-22	RCM-18-23H	RCM-18-24H	RCM-18-24H
	w/o hook	RCM-18-14	RCM-18-14								RCM-18-24	RCM-18-24
Item no.	22	w/hook	RCM-22-14H	RCM-22-14H	RCM-22-13H	RCM-22-12	RCM-22-11	RCM-22-21	RCM-22-22	RCM-22-23H	RCM-22-24H	RCM-22-24H
	w/o hook	RCM-22-14	RCM-22-14								RCM-22-24	RCM-22-24

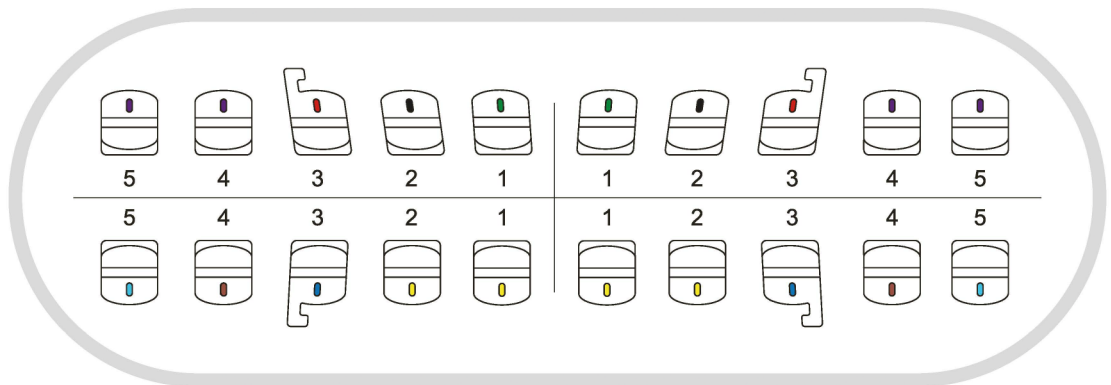

### Mandibular

torque		-17°	-12°	0°	-6°	-6°	-6°	-6°	0°	-12°	-17°	
ang.		0°	0°	3°	0°	0°	0°	0°	3°	0°	0°	
width		3.25	3.25	3.4	2.75	2.75	2.75	2.75	3.4	3.25	3.25	
Item no.	18	w/hook	RCM-18-45H	RCM-18-44H	RCM-18-43H	RCM-18-41	RCM-18-41	RCM-18-31	RCM-18-31	RCM-18-33H	RCM-18-34H	RCM-18-35H
	w/o hook	RCM-18-45	RCM-18-44								RCM-18-34	RCM-18-35
Item no.	22	w/hook	RCM-22-45H	RCM-22-44H	RCM-22-43H	RCM-22-41	RCM-22-41	RCM-22-31	RCM-22-31	RCM-22-33H	RCM-22-34H	RCM-22-35H
	w/o hook	RCM-22-45	RCM-22-44								RCM-22-34	RCM-22-35

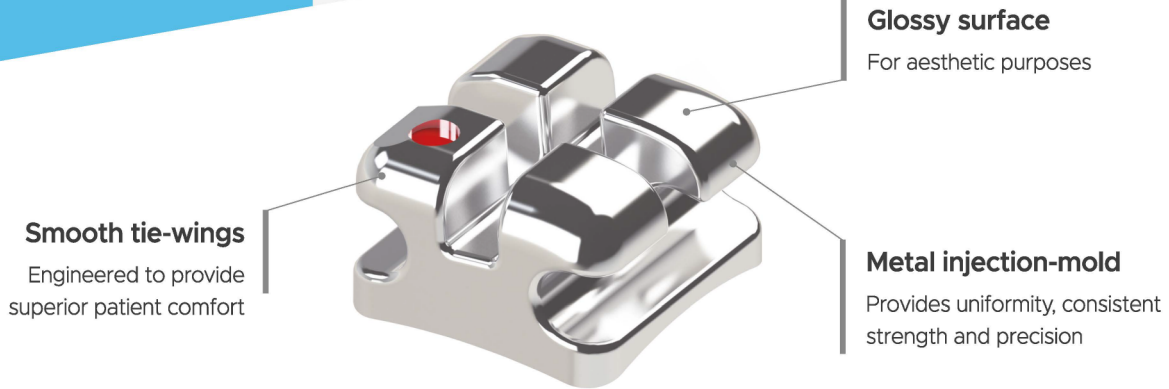

**Meshed Bonding base**  
Meshed bonding base maximizes bonding retention and eases the de-bonding process



**Ample tie wings area**  
For easy chain and tie ligation

- Unique mesh type base with an exceptional stainless steel body allows for outstanding durability while processing.
- Mechanically made convenient design allows for reduced treatment time.

### Meta<sup>1</sup> Patient Kits

Description	EDGEWISE		ROTH		MBT	
	018	022	018	022	018	022
Upper/Lower 3-3 HK3	M1E-18-331	M1E-22-331	M1R-18-331	M1R-22-331	M1M-18-331	M1M-22-331
Upper 3-3 HK3	M1E-18-301	M1E-22-301	M1R-18-301	M1R-22-301	M1M-18-301	M1M-22-301
Lower 3-3 HK3	M1E-18-031	M1E-22-031	M1R-18-031	M1R-22-031	M1M-18-031	M1M-22-031
Upper/Lower 5-5 HK3	M1E-18-551	M1E-22-551	M1R-18-551	M1R-22-551	M1M-18-551	M1M-22-551
Upper 5-5 HK3	M1E-18-501	M1E-22-501	M1R-18-501	M1R-22-501	M1M-18-501	M1M-22-501
Lower 5-5 HK3	M1E-18-051	M1E-22-051	M1R-18-051	M1R-22-051	M1M-18-051	M1M-22-051
Upper/Lower 5-5 HK345	M1E-18-553	M1E-22-553	M1R-18-553	M1R-22-553	M1M-18-553	M1M-22-553
Upper 5-5 HK345	M1E-18-503	M1E-22-503	M1R-18-503	M1R-22-503	M1M-18-503	M1M-22-503
Lower 5-5 HK345	M1E-18-053	M1E-22-053	M1R-18-053	M1R-22-053	M1M-18-053	M1M-22-053

### Meta<sup>2</sup> Patient Kits

Description	EDGEWISE		ROTH		MBT	
	018	022	018	022	018	022
Upper/Lower 3-3 HK3	M2E-18-331	M2E-22-331	M2R-18-331	M2R-22-331	M2M-18-331	M2M-22-331
Upper 3-3 HK3	M2E-18-301	M2E-22-301	M2R-18-301	M2R-22-301	M2M-18-301	M2M-22-301
Lower 3-3 HK3	M2E-18-031	M2E-22-031	M2R-18-031	M2R-22-031	M2M-18-031	M2M-22-031
Upper/Lower 5-5 HK3	M2E-18-551	M2E-22-551	M2R-18-551	M2R-22-551	M2M-18-551	M2M-22-551
Upper 5-5 HK3	M2E-18-501	M2E-22-501	M2R-18-501	M2R-22-501	M2M-18-501	M2M-22-501
Lower 5-5 HK3	M2E-18-051	M2E-22-051	M2R-18-051	M2R-22-051	M2M-18-051	M2M-22-051
Upper/Lower 5-5 HK345	M2E-18-553	M2E-22-553	M2R-18-553	M2R-22-553	M2M-18-553	M2M-22-553
Upper 5-5 HK345	M2E-18-503	M2E-22-503	M2R-18-503	M2R-22-503	M2M-18-503	M2M-22-503
Lower 5-5 HK345	M2E-18-053	M2E-22-053	M2R-18-053	M2R-22-053	M2M-18-053	M2M-22-053



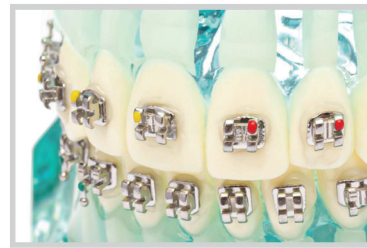
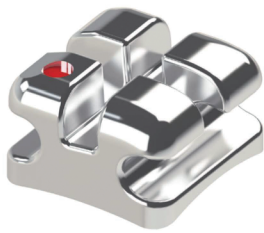

## METAL SERIES

Meta<sup>1</sup> Mini ROTH Bracket

## Maxillary

torque		-7°	-7°	0°	8°	12°	12°	8°	0°	-7°	-7°	
ang.		0°	0°	10°	9°	5°	5°	9°	10°	0°	0°	
width		2.8	2.8	2.8	2.6	3.2	3.2	2.6	2.8	2.8	2.8	
Item no.	18	w/hook	M1R-18-14H	M1R-18-14H	M1R-18-13H	M1R-18-12	M1R-18-11	M1R-18-21	M1R-18-22	M1R-18-23H	M1R-18-24H	M1R-18-24H
	w/o hook	M1R-18-14	M1R-18-14								M1R-18-24	M1R-18-24
Item no.	22	w/hook	M1R-22-14H	M1R-22-14H	M1R-22-13H	M1R-22-12	M1R-22-11	M1R-22-21	M1R-22-22	M1R-22-23H	M1R-22-24H	M1R-22-24H
	w/o hook	M1R-22-14	M1R-22-14								M1R-22-24	M1R-22-24

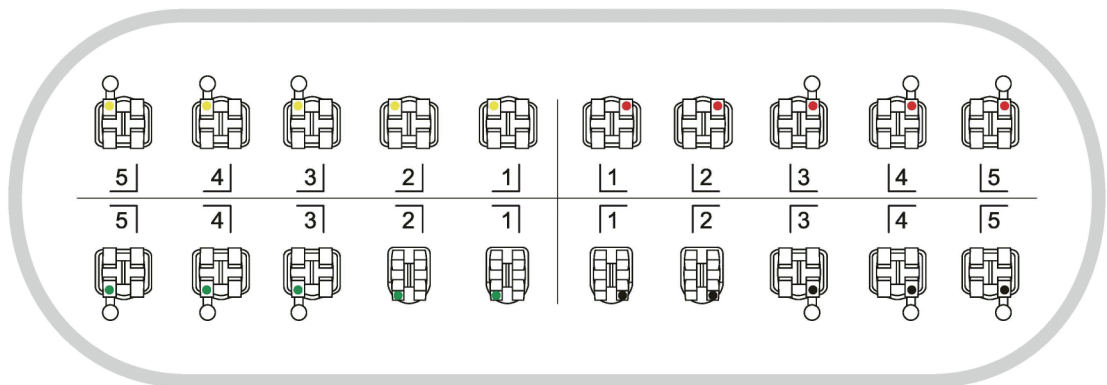

## Mandibular

torque		-17°	-17°	-11°	0°	0°	0°	0°	-11°	-17°	-17°	
ang.		0°	0°	7°	0°	0°	0°	0°	7°	0°	0°	
width		2.8	2.8	2.8	2.3	2.3	2.3	2.3	2.8	2.8	2.8	
Item no.	18	w/hook	M1R-18-45H	M1R-18-44H	M1R-18-43H	M1R-18-41	M1R-18-41	M1R-18-31	M1R-18-31	M1R-18-33H	M1R-18-34H	M1R-18-35H
	w/o hook	M1R-18-45	M1R-18-44								M1R-18-34	M1R-18-35
Item no.	22	w/hook	M1R-22-45H	M1R-22-44H	M1R-22-43H	M1R-22-41	M1R-22-41	M1R-22-31	M1R-22-31	M1R-22-33H	M1R-22-34H	M1R-22-35H
	w/o hook	M1R-22-45	M1R-22-44								M1R-22-34	M1R-22-35





METAL SERIES

Meta<sup>1</sup> Mini MBT Bracket

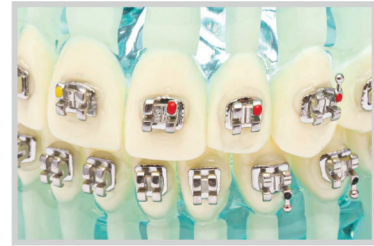
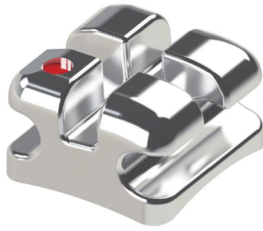

Maxillary

torque		-7°	-7°	0°	10°	17°	17°	10°	0°	-7°	-7°	
ang.		0°	0°	8°	8°	4°	4°	8°	8°	0°	0°	
width		2.8	2.8	2.8	2.8	3.3	3.3	2.8	2.8	2.8	2.8	
Item no.	18	w/hook	M1M-18-14H	M1M-18-14H	M1M-18-13H	M1M-18-12	M1M-18-11	M1M-18-21	M1M-18-22	M1M-18-23H	M1M-18-24H	M1M-18-24H
		w/o hook	M1M-18-14	M1M-18-14							M1M-18-24	M1M-18-24
	22	w/hook	M1M-22-14H	M1M-22-14H	M1M-22-13H	M1M-22-12	M1M-22-11	M1M-22-21	M1M-22-22	M1M-22-23H	M1M-22-24H	M1M-22-24H
		w/o hook	M1M-22-14	M1M-22-14							M1M-22-24	M1M-22-24

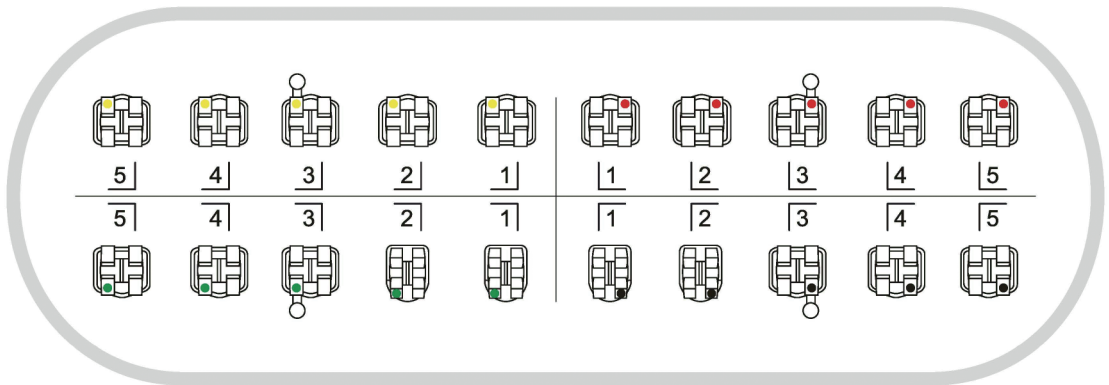

Mandibular

torque		-17°	-12°	-6°	-6°	-6°	-6°	-6°	-6°	-12°	-17°	
ang.		0°	0°	3°	0°	0°	0°	0°	3°	0°	0°	
width		2.8	2.8	2.8	2.3	2.3	2.3	2.3	2.8	2.8	2.8	
Item no.	18	w/hook	M1M-18-45H	M1M-18-44H	M1M-18-43H	M1M-18-41	M1M-18-41	M1M-18-31	M1M-18-31	M1M-18-33H	M1M-18-34H	M1M-18-35H
		w/o hook	M1M-18-45	M1M-18-44							M1M-18-34	M1M-18-35
	22	w/hook	M1M-22-45H	M1M-22-44H	M1M-22-43H	M1M-22-41	M1M-22-41	M1M-22-31	M1M-22-31	M1M-22-33H	M1M-22-34H	M1M-22-35H
		w/o hook	M1M-22-45	M1M-22-44							M1M-22-34	M1M-22-35



## METAL SERIES

# Meta<sup>2</sup> CNC Process ROTH Bracket

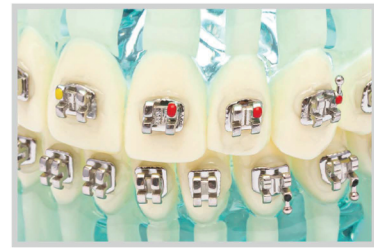
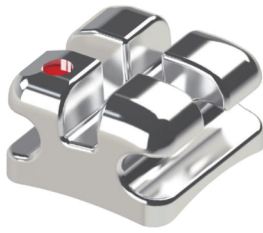

### Maxillary

torque		-7°	-7°	0°	8°	12°	12°	8°	0°	-7°	-7°	
ang.		0°	0°	11°	9°	5°	5°	9°	11°	0°	0°	
width		2.8	2.8	2.8	2.8	3.2	3.2	2.8	2.8	2.8	2.8	
Item no.	18	w/hook	M2R-18-14H	M2R-18-14H	M2R-18-13H	M2R-18-12	M2R-18-11	M2R-18-21	M2R-18-22	M2R-18-23H	M2R-18-24H	M2R-18-24H
	w/o hook	M2R-18-14	M2R-18-14								M2R-18-24	M2R-18-24
Item no.	22	w/hook	M2R-22-14H	M2R-22-14H	M2R-22-13H	M2R-22-12	M2R-22-11	M2R-22-21	M2R-22-22	M2R-22-23H	M2R-22-24H	M2R-22-24H
	w/o hook	M2R-22-14	M2R-22-14								M2R-22-24	M2R-22-24

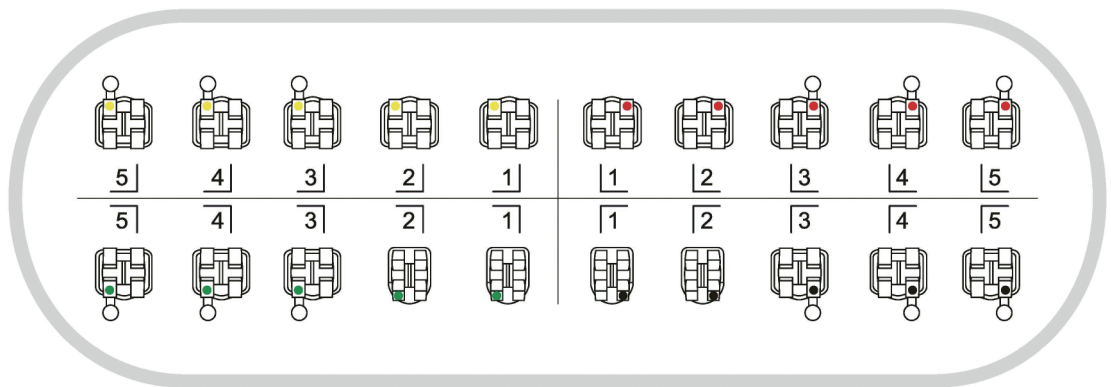

### Mandibular

torque		-22°	-17°	-11°	-1°	-1°	-1°	-1°	-11°	-17°	-22°	
ang.		0°	0°	5°	0°	0°	0°	0°	5°	0°	0°	
width		2.8	2.8	2.8	2.45	2.45	2.45	2.45	2.8	2.8	2.8	
Item no.	18	w/hook	M2R-18-45H	M2R-18-44H	M2R-18-43H	M2R-18-41	M2R-18-41	M2R-18-31	M2R-18-31	M2R-18-33H	M2R-18-34H	M2R-18-35H
	w/o hook	M2R-18-45	M2R-18-44								M2R-18-34	M2R-18-35
Item no.	22	w/hook	M2R-22-45H	M2R-22-44H	M2R-22-43H	M2R-22-41	M2R-22-41	M2R-22-31	M2R-22-31	M2R-22-33H	M2R-22-34H	M2R-22-35H
	w/o hook	M2R-22-45	M2R-22-44								M2R-22-34	M2R-22-35



METAL SERIES

Meta<sup>2</sup> CNC Process MBT Bracket

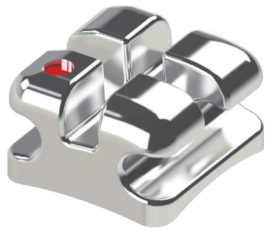

Maxillary

torque		-7°	-7°	-7°	10°	17°	17°	10°	-7°	-7°	-7°	
ang.		0°	0°	8°	8°	4°	4°	8°	8°	0°	0°	
width		2.8	2.8	2.8	2.8	3.2	3.2	2.8	2.8	2.8	2.8	
Item no.	18	w/hook	M2M-18-14H	M2M-18-14H	M2M-18-13H	M2M-18-12	M2M-18-11	M2M-18-21	M2M-18-22	M2M-18-23H	M2M-18-24H	M2M-18-24H
		w/o hook	M2M-18-14	M2M-18-14							M2M-18-24	M2M-18-24
Item no.	22	w/hook	M2M-22-14H	M2M-22-14H	M2M-22-13H	M2M-22-12	M2M-22-11	M2M-22-21	M2M-22-22	M2M-22-23H	M2M-22-24H	M2M-22-24H
		w/o hook	M2M-22-14	M2M-22-14							M2M-22-24	M2M-22-24

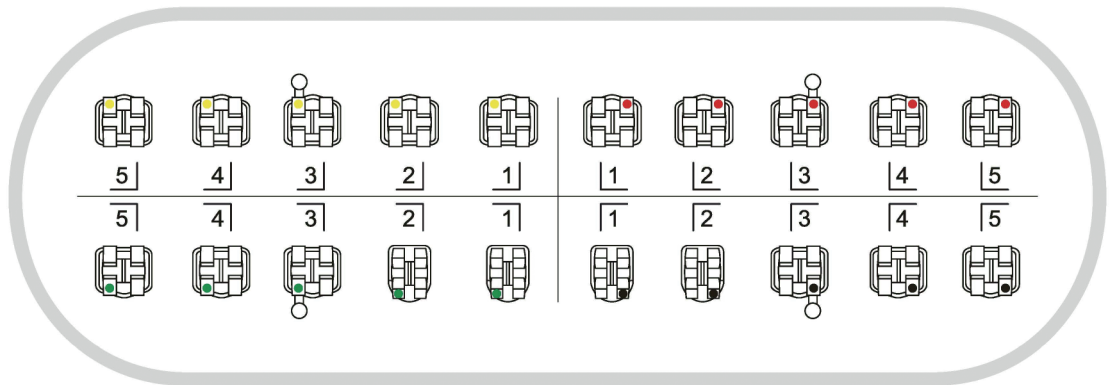

Mandibular

torque		-22°	-17°	-6°	-6°	-6°	-6°	-6°	-6°	-17°	-22°	
ang.		2°	2°	3°	0°	0°	0°	0°	3°	2°	2°	
width		2.8	2.8	2.8	2.45	2.45	2.45	2.45	2.8	2.8	2.8	
Item no.	18	w/hook	M2M-18-45H	M2M-18-44H	M2M-18-43H	M2M-18-41	M2M-18-41	M2M-18-31	M2M-18-31	M2M-18-33H	M2M-18-34H	M2M-18-35H
		w/o hook	M2M-18-45	M2M-18-44							M2M-18-34	M2M-18-35
Item no.	22	w/hook	M2M-22-45H	M2M-22-44H	M2M-22-43H	M2M-22-41	M2M-22-41	M2M-22-31	M2M-22-31	M2M-22-33H	M2M-22-34H	M2M-22-35H
		w/o hook	M2M-22-45	M2M-22-44							M2M-22-34	M2M-22-35

# ORTHODONTIC ARCHWIRES & SPRINGS

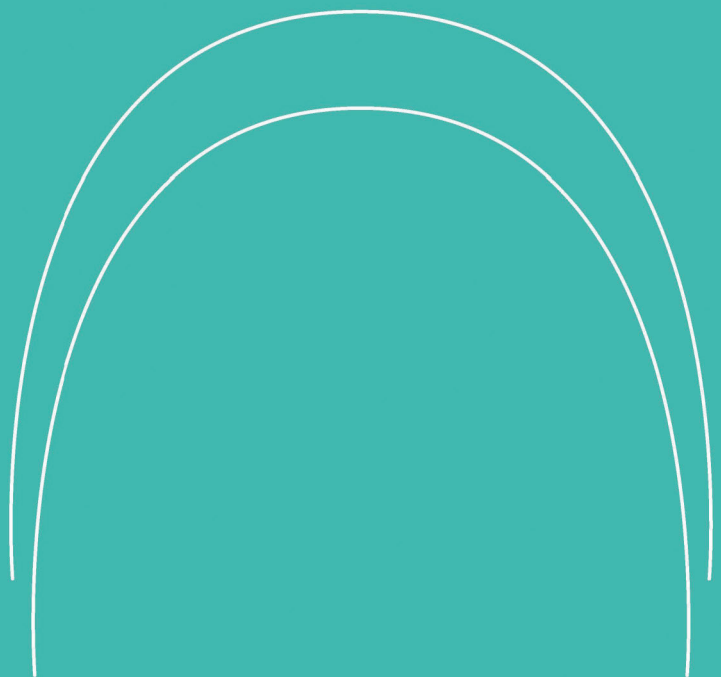

## ARCHWIRES

Super Elastic NITI Archwire \_ 19

Thermal Active NITI Archwire \_ 19

Stainless Steel Archwire \_ 20

Reverse Curve NITI Archwire \_ 20

► Material Comparison Single Cycle  
10mm Span

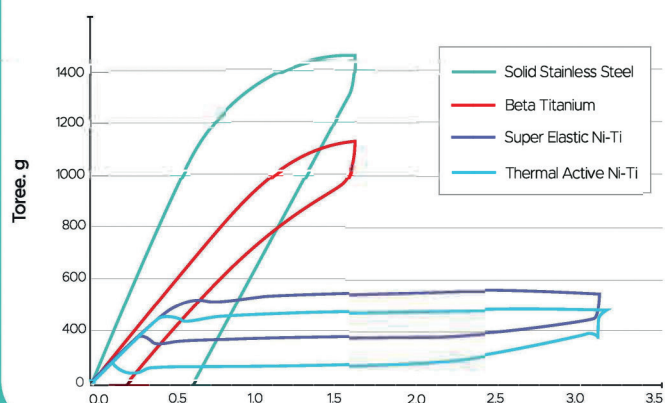



## ARCHWIRES

## Super Elastic NITI Archwire &amp; Thermal Active NITI Archwire

## Super Elastic NITI Archwire

Round	Size	Square	Ovoid	Natural
Upper	0.012" / 0.31mm	ASE111-1U	ASE112-1U	ASE113-1U
	0.014" / 0.35mm	ASE111-2U	ASE112-2U	ASE113-2U
	0.016" / 0.41mm	ASE111-3U	ASE112-3U	ASE113-3U
	0.018" / 0.46mm	ASE111-4U	ASE112-4U	ASE113-4U
	0.020" / 0.51mm	ASE111-5U	ASE112-5U	ASE113-5U
Lower	0.012" / 0.31mm	ASE111-1L	ASE112-1L	ASE113-1L
	0.014" / 0.35mm	ASE111-2L	ASE112-2L	ASE113-2L
	0.016" / 0.41mm	ASE111-3L	ASE112-3L	ASE113-3L
	0.018" / 0.46mm	ASE111-4L	ASE112-4L	ASE113-4L
	0.020" / 0.51mm	ASE111-5L	ASE112-5L	ASE113-5L
Rectangular	Size	Square	Ovoid	Natural
Upper	0.016x0.016" / 0.41x0.41mm	ASE121-1U	ASE122-1U	ASE123-1U
	0.016x0.022" / 0.41x0.56mm	ASE121-2U	ASE122-2U	ASE123-2U
	0.017x0.022" / 0.43x0.56mm	ASE121-3U	ASE122-3U	ASE123-3U
	0.017x0.025" / 0.43x0.64mm	ASE121-4U	ASE122-4U	ASE123-4U
	0.018x0.022" / 0.46x0.56mm	ASE121-5U	ASE122-5U	ASE123-5U
	0.018x0.025" / 0.46x0.64mm	ASE121-6U	ASE122-6U	ASE123-6U
	0.019x0.025" / 0.48x0.64mm	ASE121-7U	ASE122-7U	ASE123-7U
	0.021x0.025" / 0.53x0.64mm	ASE121-8U	ASE122-8U	ASE123-8U
Lower	0.016x0.016" / 0.41x0.41mm	ASE121-1L	ASE122-1L	ASE123-1L
	0.016x0.022" / 0.41x0.56mm	ASE121-2L	ASE122-2L	ASE123-2L
	0.017x0.022" / 0.43x0.56mm	ASE121-3L	ASE122-3L	ASE123-3L
	0.017x0.025" / 0.43x0.64mm	ASE121-4L	ASE122-4L	ASE123-4L
	0.018x0.022" / 0.46x0.56mm	ASE121-5L	ASE122-5L	ASE123-5L
	0.018x0.025" / 0.46x0.64mm	ASE121-6L	ASE122-6L	ASE123-6L
	0.019x0.025" / 0.48x0.64mm	ASE121-7L	ASE122-7L	ASE123-7L
	0.021x0.025" / 0.53x0.64mm	ASE121-8L	ASE122-8L	ASE123-8L

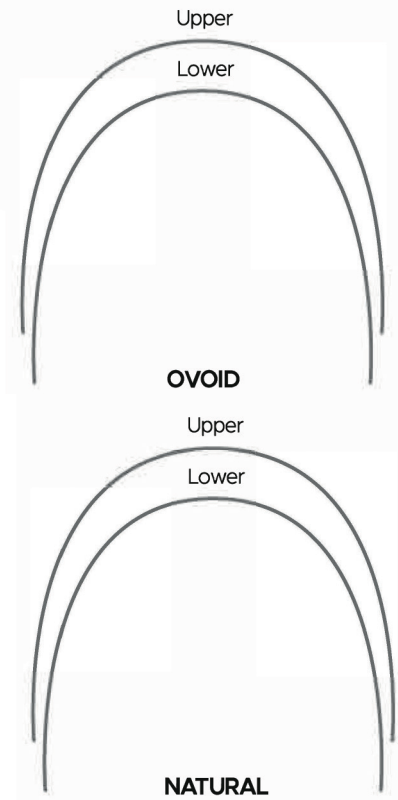



## ARCHWIRES & SPRINGS

# Stainless Steel Archwire & Reverse Curve NITI Archwire NITI Springs & Close Spring With Eye-let

### Stainless Steel Archwire

Round	Size	Ovoid	Natural
Upper	0.012" / 0.31mm	ASS412-1U	ASS413-1U
	0.014" / 0.35mm	ASS412-2U	ASS413-2U
	0.016" / 0.41mm	ASS412-3U	ASS413-3U
	0.018" / 0.46mm	ASS412-4U	ASS413-4U
	0.020" / 0.51mm	ASS412-5U	ASS413-5U
Lower	0.012" / 0.31mm	ASS412-1L	ASS413-1L
	0.014" / 0.35mm	ASS412-2L	ASS413-2L
	0.016" / 0.41mm	ASS412-3L	ASS413-3L
	0.018" / 0.46mm	ASS412-4L	ASS413-4L
	0.020" / 0.51mm	ASS412-5L	ASS413-5L
Rectangular	Size	Ovoid	Natural
Upper	0.016x0.016" / 0.41x0.41mm	ASS422-1U	ASS423-1U
	0.016x0.022" / 0.41x0.56mm	ASS422-2U	ASS423-2U
	0.017x0.022" / 0.43x0.56mm	ASS422-3U	ASS423-3U
	0.017x0.025" / 0.43x0.64mm	ASS422-4U	ASS423-4U
	0.018x0.022" / 0.46x0.56mm	ASS422-5U	ASS423-5U
	0.018x0.025" / 0.46x0.64mm	ASS422-6U	ASS423-6U
	0.019x0.025" / 0.48x0.64mm	ASS422-7U	ASS423-7U
	0.021x0.025" / 0.53x0.64mm	ASS422-8U	ASS423-8U
Lower	0.016x0.016" / 0.41x0.41mm	ASS422-1L	ASS423-1L
	0.016x0.022" / 0.41x0.56mm	ASS422-2L	ASS423-2L
	0.017x0.022" / 0.43x0.56mm	ASS422-3L	ASS423-3L
	0.017x0.025" / 0.43x0.64mm	ASS422-4L	ASS423-4L
	0.018x0.022" / 0.46x0.56mm	ASS422-5L	ASS423-5L
	0.018x0.025" / 0.46x0.64mm	ASS422-6L	ASS423-6L
	0.019x0.025" / 0.48x0.64mm	ASS422-7L	ASS423-7L
	0.021x0.025" / 0.53x0.64mm	ASS422-8L	ASS423-8L

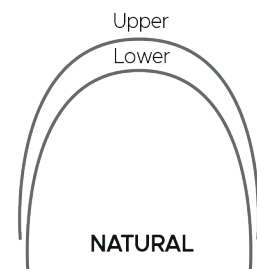
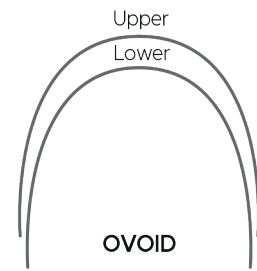

### NITI Springs

Type	Specification	Size	Package
		0.012" / 0.31mm	
Open Spring	180mm	SN02-1218	2x1



### Close Spring With Eye-let

Type	Specification	Size	Package
		0.010" / 0.25mm	
Close Spring	9mm	SC03-1009	10x1
	12mm	SC03-1012	



### Stainless Steel Ligature Ties

Size	Item No.	Package	Remark
0.012	TL01-02	100*1	with hooks for elastics

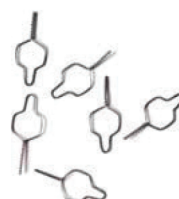

# ORTHODONTIC TUBES

## BONDABLE BUCCAL TUBES

1st Molar \_ 22

2nd Molar \_ 22



# BONDABLE

## BONDABLE BUCCAL TUBES

### First Molar Bondable Buccal Tubes

Single Bondable Tubes (1G)

System	Teeth	Torque	Offset	In/Out	Width	Item No.			
						Convertible		Non-convertible	
						18	22	18	22
Roth	UR	-14°	10°	0.4	4	SBC-R18-161G	SBC-R22-161G	SBN-R18-161G	SBN-R22-161G
	UL	-14°	10°	0.4	4	SBC-R18-261G	SBC-R22-261G	SBN-R18-261G	SBN-R22-261G
	LL	-25°	4°	0.4	4	SBC-R18-361G	SBC-R22-361G	SBN-R18-361G	SBN-R22-361G
	LR	-25°	4°	0.4	4	SBC-R18-461G	SBC-R22-461G	SBN-R18-461G	SBN-R22-461G
MBT	UR	-14°	10°	0.4	4	SBC-M18-161G	SBC-M22-161G	SBN-M18-161G	SBN-M22-161G
	UL	-14°	10°	0.4	4	SBC-M18-261G	SBC-M22-261G	SBN-M18-261G	SBN-M22-261G
	LL	-20°	0°	0.4	4	SBC-M18-361G	SBC-M22-361G	SBN-M18-361G	SBN-M22-361G
	LR	-20°	0°	0.4	4	SBC-M18-461G	SBC-M22-461G	SBN-M18-461G	SBN-M22-461G



## BONDABLE BUCCAL TUBES

### Second Molar Bondable Buccal Tubes

Single Bondable Tubes (1G)

System	Teeth	Torque	Offset	In/Out	Width	Item No.	
						Non-convertible	
						18	22
Roth	UR	-14°	10°	0.4	3.2	SBN-R18-171G	SBN-R22-171G
	UL	-14°	10°	0.4	3.2	SBN-R18-271G	SBN-R22-271G
	LL	-25°	4°	0.4	3.2	SBN-R18-371G	SBN-R22-371G
	LR	-25°	4°	0.4	3.2	SBN-R18-471G	SBN-R22-471G
MBT	UR	-14°	10°	0.4	3.2	SBN-M18-171G	SBN-M22-171G
	UL	-14°	10°	0.4	3.2	SBN-M18-271G	SBN-M22-271G
	LL	-10°	0°	0.4	3.2	SBN-M18-371G	SBN-M22-371G
	LR	-10°	0°	0.4	3.2	SBN-M18-471G	SBN-M22-471G
Edgewise	UR	0°	6°	0.4	3.2	SBN-E18-171G	SBN-E22-171G
	UL	0°	6°	0.4	3.2	SBN-E18-271G	SBN-E22-271G
	LL	0°	6°	0.4	3.2	SBN-E18-371G	SBN-E22-371G
	LR	0°	6°	0.4	3.2	SBN-E18-471G	SBN-E22-471G



# ORTHODONTIC ELASTIC RINGS

## ELASTIC-RING

Ligature tie \_ 24













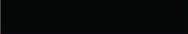

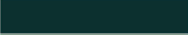

Power chain \_ 25





## ELASTIC RING















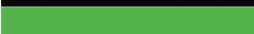









### Ligature tie

Color	Item No.		Package
	Type T		
	Blue	ELT12-01	38*26 1040pcs/ bag
	Baby blue	ELT12-02	
	Sky blue	ELT12-03	
	Black	ELT12-04	
	Spring green	ELT12-05	
	Dark green	ELT12-06	
	Forest green	ELT12-07	
	Grass green	ELT12-08	
	Orange	ELT12-09	
	Deep yellow	ELT12-10	
	White	ELT12-11	
	Clear	ELT12-12	
	Silver	ELT12-13	
	Brown	ELT12-14	
	Golden	ELT12-15	
	Banana Yellow	ELT12-16	
	Yellow	ELT12-17	
	Deep purple	ELT12-18	

Color	Item No.		Package
	Type T		
	Light violet	ELT12-19	38*26 1040pcs/ bag
	Neon purple	ELT12-20	
	Light pink	ELT12-21	
	Hot pink	ELT12-22	
	Red	ELT12-23	
	Dark red	ELT12-24	
	Apple green	ELT12-25	
	Turquoise	ELT12-26	
	Lake blue	ELT12-27	
	Rust red	ELT12-28	
	Dark blue	ELT12-29	
	Prussian blue	ELT12-30	
	Slate blue	ELT12-31	
	Bright green	ELT12-32	
	Periwinkle	ELT12-33	
	Deep black	ELT12-34	
	Deep pink	ELT12-35	
	Coral	ELT12-36	

## ELASTIC RING

## Power chain

Color	Item No.			
	long	short	continue	
	Blue	EPC21-01	EPC22-01	EPC23-01
	Baby blue	EPC21-02	EPC22-02	EPC23-02
	Sky blue	EPC21-03	EPC22-03	EPC23-03
	Black	EPC21-04	EPC22-04	EPC23-04
	Spring green	EPC21-05	EPC22-05	EPC23-05
	Dark green	EPC21-06	EPC22-06	EPC23-06
	Forest green	EPC21-07	EPC22-07	EPC23-07
	Grass green	EPC21-08	EPC22-08	EPC23-08
	Orange	EPC21-09	EPC22-09	EPC23-09
	Deep yellow	EPC21-10	EPC22-10	EPC23-10
	White	EPC21-11	EPC22-11	EPC23-11
	Clear	EPC21-12	EPC22-12	EPC23-12
	Silver	EPC21-13	EPC22-13	EPC23-13
	Brown	EPC21-14	EPC22-14	EPC23-14
	Golden	EPC21-15	EPC22-15	EPC23-15
	Banana Yellow	EPC21-16	EPC22-16	EPC23-16
	Yellow	EPC21-17	EPC22-17	EPC23-17
	Deep purple	EPC21-18	EPC22-18	EPC23-18
	Light violet	EPC21-19	EPC22-19	EPC23-19
	Neon purple	EPC21-20	EPC22-20	EPC23-20
	Light pink	EPC21-21	EPC22-21	EPC23-21
	Hot pink	EPC21-22	EPC22-22	EPC23-22
	Red	EPC21-23	EPC22-23	EPC23-23
	Dark red	EPC21-24	EPC22-24	EPC23-24



# ORTHODONTIC ORAL CAVITY

Inside oral cavity \_ 27

Outside oral cavity \_ 27

Specification	Item No.	Package	Remark	
Crimpable hook square	ICH053-01	10*1	$L \begin{cases} 1.8 \\ 2.1 \text{ common} \\ 4 \\ 5.5 \\ 7 \end{cases}$	

INSIDE ORAL CAVITY

Specification	Item No.	Package	Remark	
Bondable hole	ILB012-03	10*1	mushroom shaped headlock button and base has arched contour	
Button chain	ILB023-11	2*1	Can be directly bonded on tooth surface, a traction with its resistance	

OUTSIDE ORAL CAVITY

Forward Pull Headgear

Specification	Item No.	Package	Remark
single bar	OFH091-01	1*1	with forehead and chin cup, provide heavy force for class III cases.
double bars	OFH091-02	1*1	Mesial movement of laterals in upper and lower jaw. Movement of groups of teeth in the arch. Protraction of anterior segments.
universal	OFH091-03	1*1	Mesial movement of laterals in upper and lower jaw. Movement of groups of teeth in the arch. Adjustable protraction of anterior segments.





# ORTHODONTIC MINI SCREW

## SMART ANCHOR

Mini Screws \_ 29



- Rounded head reduces the patient's discomfort.
- Self-drilling and tapping.

# MINI SCREW

# MINI SCREW SCREW



Cross Head Type

### Rounded and smooth head

Designed to provide superior patient comfort and minimize foreign object sensation

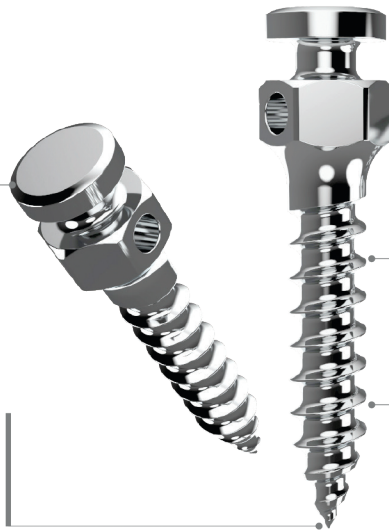

### Sharp tip

Strong and sharp designed tip provides precise and stable implantation

### Self-drilling and tapping (1)

The threads are specially engineered to have self-drilling and self-tapping functions ease implantation process

### Self-drilling and tapping (2)

Uniform thread intervals perform consistent strength and stability when implanting

- Special heating system : Unique manufacturing technique maximizes the body strength and precision.
- Various size and head options
  - : Various diameter and length options to provide customized experiences to hands-on professionals.
  - : Standard and Crosshead options to provide different needs.

#### Titanium (Standard / Crosshead)

Size / Diameter	Item No.		
	L 6mm	L 8mm	L 10mm
1.2mm	SA-1206	SA-1208	SA-1210
1.4mm	SA-1406	SA-1408	SA-1410
1.6mm	SA-1606	SA-1608	SA-1610
1.8mm	SA-1806	SA-1808	SA-1810
2.0mm	SA-2006	SA-2008	SA-2010

#### Stainless Steel (Standard / Crosshead)

Size / Diameter	Item No.		
	L 6mm	L 8mm	L 10mm
1.2mm	SSA-1206	SSA-1208	SSA-1210
1.4mm	SSA-1406	SSA-1408	SSA-1410
1.6mm	SSA-1606	SSA-1608	SSA-1610
1.8mm	SSA-1806	SSA-1808	SSA-1810
2.0mm	SSA-2006	SSA-2008	SSA-2010

